

ARCHIPENKO UNIT DESIGN RODOLFO DORDONI



Il sistema prevede contenitori a giorno, contenitori con anta oppure contenitori dotati di cassetti con maniglia a incasso in metallo tagliata a laser con finitura black-nickel lucido. Gli elementi Archipenko Unit possono essere combinati a piacere e aggregati tra loro a 2, 3 o 4 moduli grazie ad appositi passanti in metallo e ad un unico piano superiore. I mobili sono realizzati con struttura e ante in legno con spessore di 30 mm. Appoggio a terra tramite piedini tecnici regolabili in altezza. Il ripiano interno del contenitore con anta è in vetro grigio fumè spessore 6 mm, mentre il ripiano del contenitore a giorno è in legno spessore 30 mm.

Finiture:

- laccato lucido nei colori bianco, betulla, tortora, sand, grigio stone, grigio elephant, prugna, blu, moka;
- laccato opaco nei colori sand o moka;
- rovere naturale spazzolato (finitura interna ed esterna);
- rovere tinto grigio a poro aperto (finitura interna ed esterna);
- rovere laccato moka o nero a poro aperto (finitura interna ed esterna);
- pedulo di noce, finitura opaca;
- impiallacciato in ebano composto verniciato poliesteri trasparente brillante con finitura interna opaca.

N.B.: la finitura interna per la versione laccato lucido e opaco è sempre in rovere in tinta con la finitura esterna.

Archipenko Unit includes front cabinets, cabinets with doors, and cabinets with drawers provided with built-in, laser cut metal handles in bright black-nickel finish. The elements of Archipenko Unit can be easily combined together in 2, 3 or 4 modules, by using special metal loops and one top. Cabinets provided with wooden frames and doors 30 mm in thickness. Technical, vertically adjustable feet. The interior shelf of the cabinet with doors is made from smoked grey glass 6 mm in thickness; whereas the shelf of the front cabinet is made from wood 30 mm in thickness.

Finishes:

- glossy varnished in the colours white, birch grey, dove grey, sand, stone grey, elephant grey, plum, blue, moka;
- matt varnished in the colours sand or moka;
- natural brushed oak (interior and exterior finish);
- open pore, grey tinted oak (interior and exterior finish);
- open pore, moka or black lacquered oak (interior and exterior finish);
- veneered in matt finished walnut;
- veneered in ebony composite with clear, gloss polyester varnish with matt interior finish.

ATT: the interior finish for the high gloss and matt versions is always in oak matching the exterior finish.

Archipenko Unit sieht offene Schrankelemente und Schrankelemente mit Tür oder mit Schubladen vor mit versenkten Griffen aus Metall mit Laserschnitt und Glanzoberfläche in der Farbe Black-Nickel. Die Elemente von Archipenko Unit lassen sich nach Wunsch kombinieren und können aufgrund der vorgesehenen Metalldurchgänge und einer einzigen abschließenden Oberfläche untereinander zu 2, 3 oder 4 Modulen verbunden werden. Die Möbelstrukturen und Türen sind aus 30 mm dickem Holz gefertigt. Die Auflage auf dem Boden erfolgt durch technische höhenverstellbare Füße. Der Einlegeboden des Schrankelements mit Tür besteht aus 6 mm starkem rauchgrauem Glas, während der Einlegeboden des offenen Elements aus 30 mm dickem Holz gefertigt wird.

Ausführungen:

- hochglänzend lackiert in den Farben Weiß, Birke, Taubengrau, Sand, Stone-grau, Elephant-grau, Pflaume, Blau und Mokka;
- matt lackiert in den Farben Sand oder Mokka;
- gebürstete Natureiche (Innen- und Außen-ausführung);
- offenporige grau gebeizte Eiche (Innen- und Außen-ausführung);
- Eiche offenporig lackiert in den Farben Mokka und Schwarz (Innen- und Außen-ausführung);
- Nuss-Furnier mit Matt-Finish;
- mit zusammengesetztem Ebenholz furniert, mit transparentem glänzendem Polyesterlack mit matt Innen-lackierung.

ANMK: die Innenausführung bei der Hochglanzlack- und Mattversion ist immer im gleichen Ton wie die Außen-ausführung.

Le système Archipenko Unit inclut éléments de rangement ouverts, éléments de rangements avec porte et éléments de rangements à tiroirs avec poignées spéciales encastrées en métal découpé au laser avec finition black-nickel polie. Ces éléments Archipenko Unit peuvent être combinés librement et assemblés entre eux à 2, 3 ou 4 modules à travers des passants spéciaux en métal et au plateau supérieur unique. Meubles réalisés avec structure et portes en bois de 30 mm d'épaisseur. Piètement technique réglable en hauteur. L'étagère interne de l'élément de rangement avec porte est en verre gris fumé de 6 mm d'épaisseur, tandis que l'étagère de l'élément de rangement ouvert est en bois de 30 mm d'épaisseur.

Finitions :

- laqué brillant dans les couleurs blanc, bouleau, tourterelle, sand, gris stone, gris éléphant, prune, bleu, moka;
- laqué mat dans les couleurs sand ou moka.
- chêne naturel brossé (finition intérieure et extérieure);
- chêne à pore ouvert teinté dans la couleur gris; (finition intérieure et extérieure);
- chêne à pore ouvert laqué dans les couleurs moka ou noir; (finition intérieure et extérieure);
- noyer mat.
- plaqué en ébène composée vernie polyester transparent brillant avec finition intérieure mate.

RMQ : la finition intérieure pour la version laquée mate et brillante est toujours en chêne en teinte avec la finition extérieure.

NOCE | WALNUT

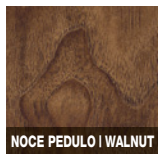

ROVERE | OAK

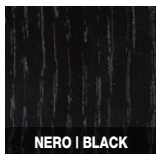
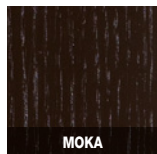
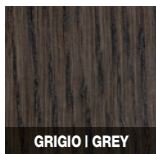

EBANO | EBONY

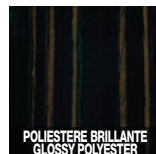

LACCATO LUCIDO | GLOSSY LACQUERED

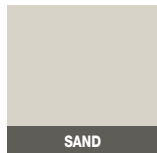

LACCATO OPACO | MATT LACQUERED

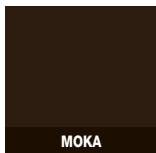
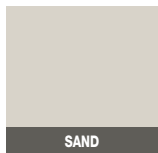

CONTENITORI CON CASSETTI / CABINETS WITH DRAWERS

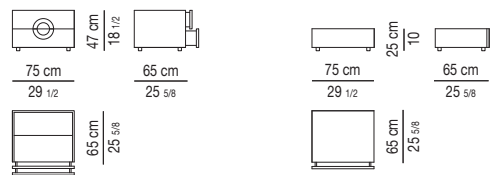

CONTENITORI CON ANTA DX E SX / CABINETS WITH LEFT OR RIGHT DOOR

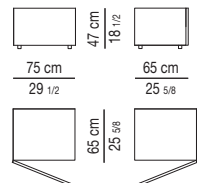

CONTENITORI A GIORNO / FRONT CABINETS

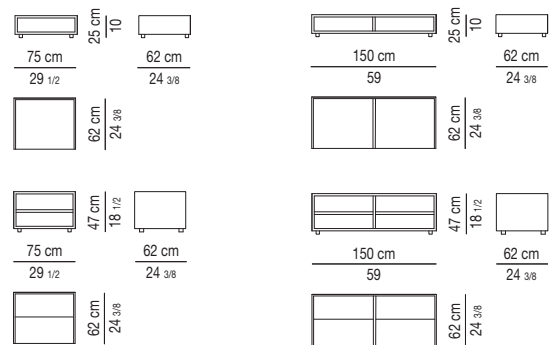

COMPOSIZIONI / ARRANGEMENTS

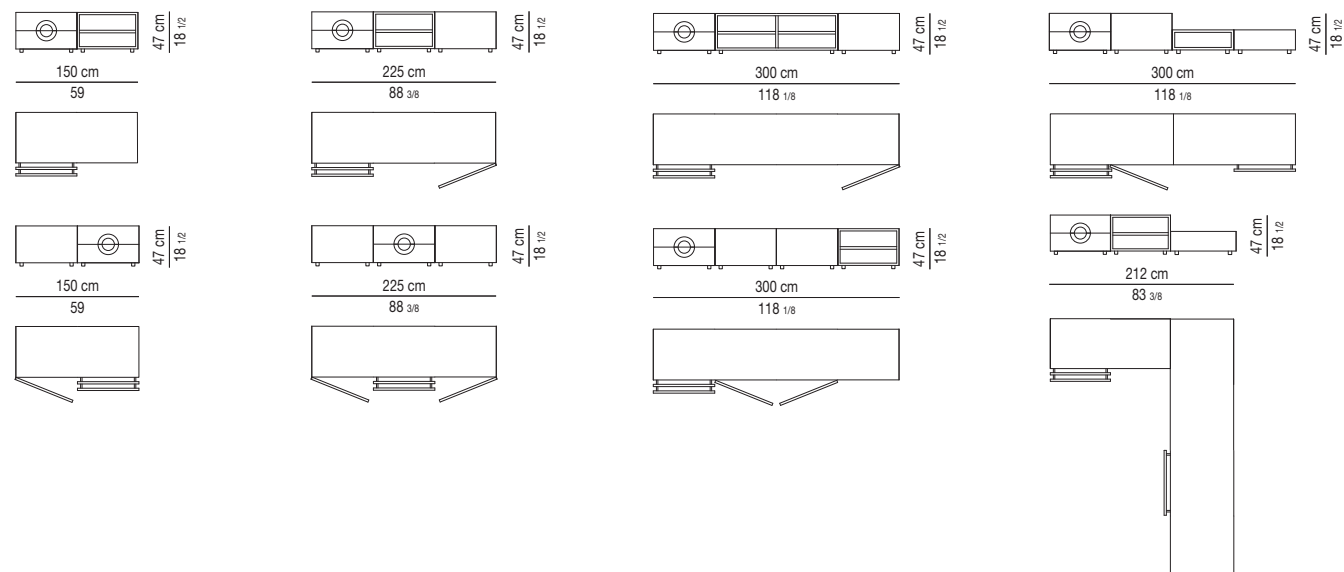

TOP 2 MODULI / 2 MODULES TOP

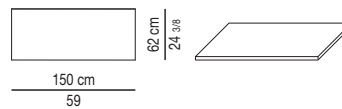

TOP 3 MODULI / 3 MODULES TOP

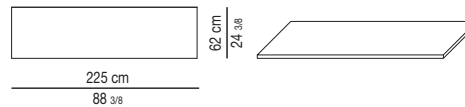

TOP 4 MODULI / 4 MODULES TOP

