

Minotti

SHERMAN DESIGN RODOLFO DORDONI



Struttura: in metallo con cinghie elastiche intrecciate ad alta componente di caucciù. Schienali e braccioli in legno multistrati.

Preparazione della struttura: in poliuretano espanso a quote differenziate ad alta densità. Imbottitura bracciolo e schienale realizzata con materiale poliuretano termosensibile. Ulteriore rivestimento della struttura con fibra termolegata di forte spessore ed accoppiata con tela di cotone bianca.

Cuscinatura: imbottitura cuscino sedile in piuma d'oca canalizzata con inserto centrale in poliuretano espanso a quote differenziate ad alta resilienza. Cuscini schienale imbottiti in piuma d'oca canalizzata con inserto centrale in materiale poliuretano termosensibile. Cuscini sedile reversibili.

Sfoderabilità: rivestimento sfoderabile solo in tessuto, in pelle fisso solo per la struttura, cuscini schienale e sedile sfoderabili.

Base: appoggio a terra tramite basi stampate in alluminio (disegno esclusivo Minotti Studio). Le finiture disponibili per la base sono: spazzolata lucido con vernice trasparente applicata successivamente oppure verniciata color Peltro con finitura extra-lucida anti-touch. Scivolante protettivo in Hytrel® (gomma morbida antigraffio).

Frame: metal with plaited elastic straps with a high rubber content. Multi plywood back and arm.

Frame preparation: structure let into high-density polyurethane foam in different densities. Back and arm padding in thermo-sensitive polyurethane. An additional cover for the frame in a thick thermo-bonded fiber coupled with a white cotton fabric.

Cushions: channeled goose down padding for the seat cushion with central insert in high-density polyurethane foam in different densities. Channeled goose down padding for the back cushions with central insert in thermo-sensitive polyurethane. Reversible seat cushions.

Cover: removable fabric upholstery only, non-removable leather for the structure only, removable back and seat cushions.

Base: molded aluminum floor base (exclusive design by Minotti Studio). The base finishings are: brushed with bright finish and with transparent finish applied at a later stage; Pewter color with extra-glossy anti-touch finish. Protective Hytrel® (soft scratchproof rubber) glide.

Struktur: Metall mit elastischen Riemen mit hohem Kautschukanteil. Rücken- und Armlehnen aus Sperrholz. **Aufbereitung des Gestells:** Unterlage aus unterschiedlich dick geschäumtem, hochdichtem Polyurethan. Polsterung der Arm- und Rückenlehne aus "wärmesensiblen" Polyurethanmaterial. Strukturbezug aus dicker, thermofixierter Faser kombiniert mit weißem Baumwolltuch.

Kissenpolsterung: Sitzkissenfüllung mit kanalisierten Gänsedaunen mit einem Einsatz aus unterschiedlich dick geschäumtem, hochdichtem Polyurethan. Rückenkissenfüllung mit kanalisierten Gänsedaunen mit einem Einsatz aus "wärmesensiblen" Polyurethanmaterial. Die Sitzkissen sind reversibel.

Abziehbarkeit: Nur Stoffbezüge sind vollkommen abziehbar, Lederbezüge sind nur an der Struktur fest, Sitz- und Rückenkissen sind abziehbar.

Gestell: Gestell mit gepressten Aluminiumfüßen (exklusives Design von Minotti Studio). Folgende Ausführungen sind erhältlich: Glänzend gebürstet mit transparenter Lackierung; zinnfarbig lackiert mit glänzendem Anti-Touch-Finish. Gleitschutz aus Hytrel® (weicher, kratzfester Gummi).

Structure : en métal avec des courroies élastiques entrelacées à forte teneur en caoutchouc. Dossiers et accoudoirs en bois contreplaqué.

Préparation de la structure : en polyuréthane expansé à épaisseurs différentes à haute densité. Garnissage de l'accoudoir et du dossier réalisé en matériau polyuréthanique termosensible. Revêtement complémentaire de la structure avec de la fibre thermoliée de forte épaisseur et couplée avec de la toile de coton blanche.

Coussins : garnissage de l'assise en plume d'oie canalisée avec insert central en polyuréthane expansé à épaisseurs différentes à haute résilience. Coussins du dossier rembourrés en plume d'oie canalisée avec insert central en matériau polyuréthanique termosensible. Coussins d'assise réversibles.

Déhoussage : seul le revêtement en tissu est déhoussable. Le revêtement en cuir de la structure est fixe, celui des coussins du dossier et de l'assise est déhoussable.

Base : appui au sol par bases (dessin exclusif Minotti Studio) estampées en aluminium. Les finitions disponibles pour la base sont : brossé finition brillante avec peinture transparente successivement ; peinture couleur Etain avec finition extra-brillante anti-traces. Patins de protection en Hytrel® (gomme souple anti-rayure).

FINITURE BASE | BASE FINISHES

ALLUMINIO | ALUMINUM



SPAZZOLATO LUCIDO
GLOSSY BRUSHED

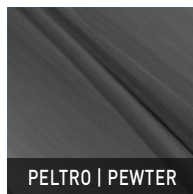

PELTRO | PEWTER

DIVANO | SOFA

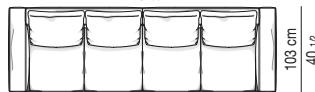
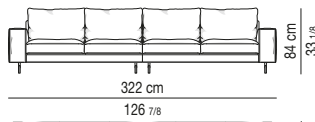
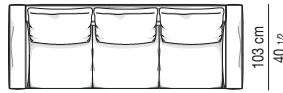
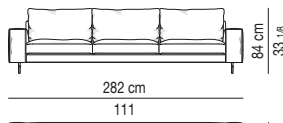
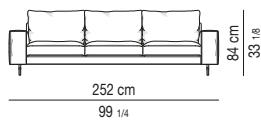
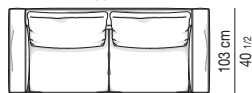
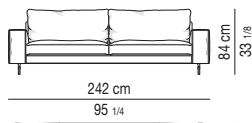
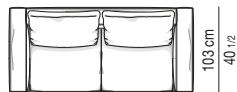
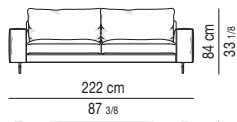
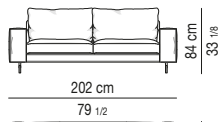
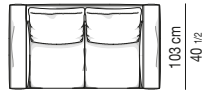
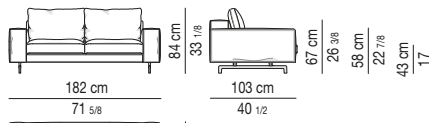

Divano composto da 1 elemento terminale sx cm 161 e da un elemento terminale dx cm 161.

Arrangement made up of 1 element with arm sx cm 161 and one element with arm dx cm 161.

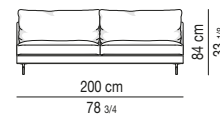
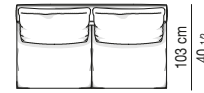
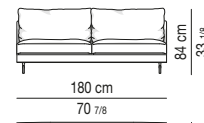

ELEMENTO CENTRALE | CENTRAL ELEMENT

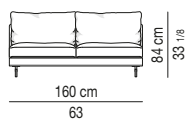
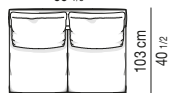
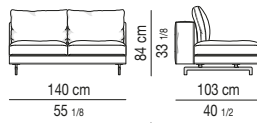

ELEMENTO TERMINALE | ELEMENT WITH 1 ARMREST

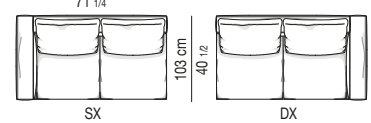
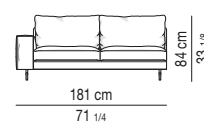
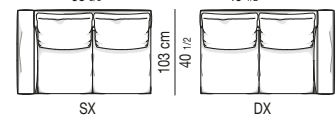
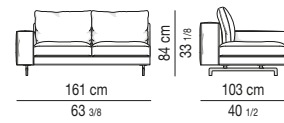

DIVANO ANGOLARE | CORNER SOFA

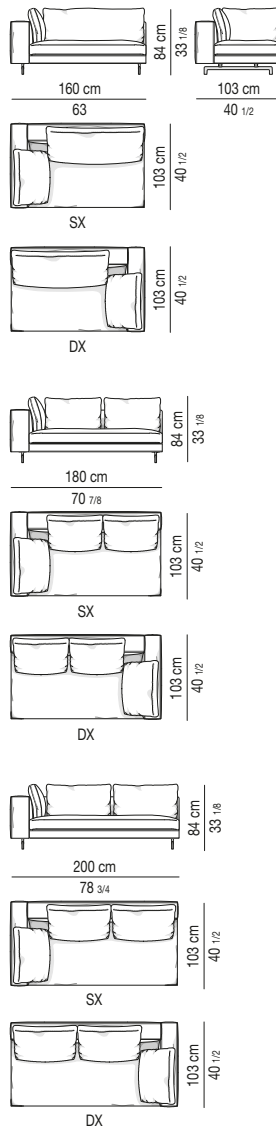
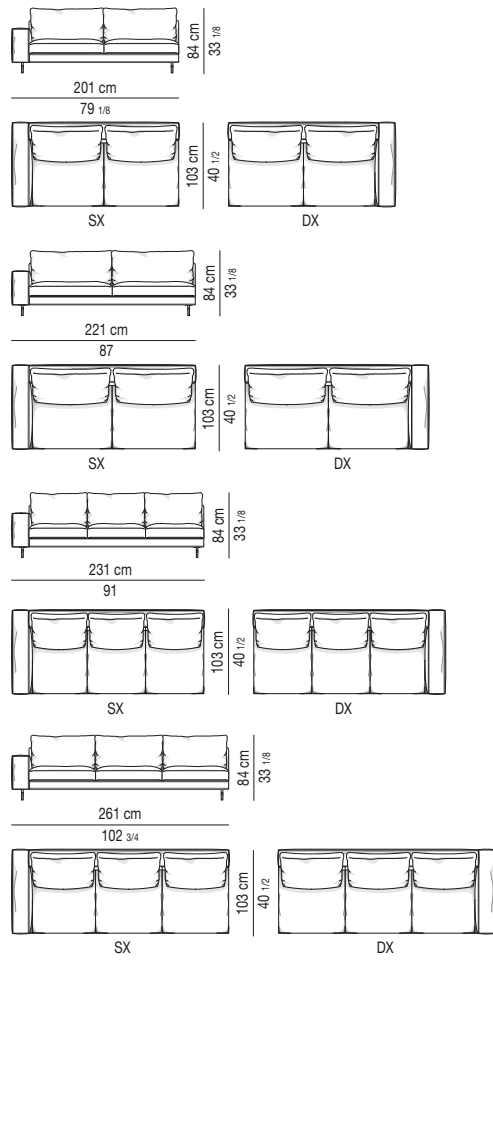

DIVANO ANGOLARE CON PENISOLA CORNER SOFA WITH OPEN-END ELEMENT

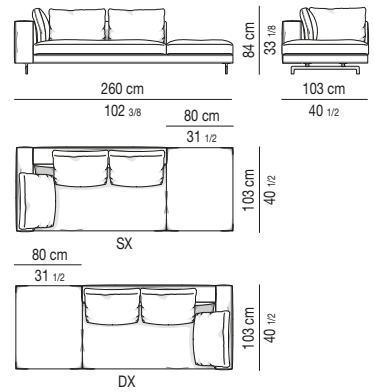

ELEMENTO PENISOLA SENZA BRACCIOLO OPEN-END ELEMENT WITHOUT ARMREST

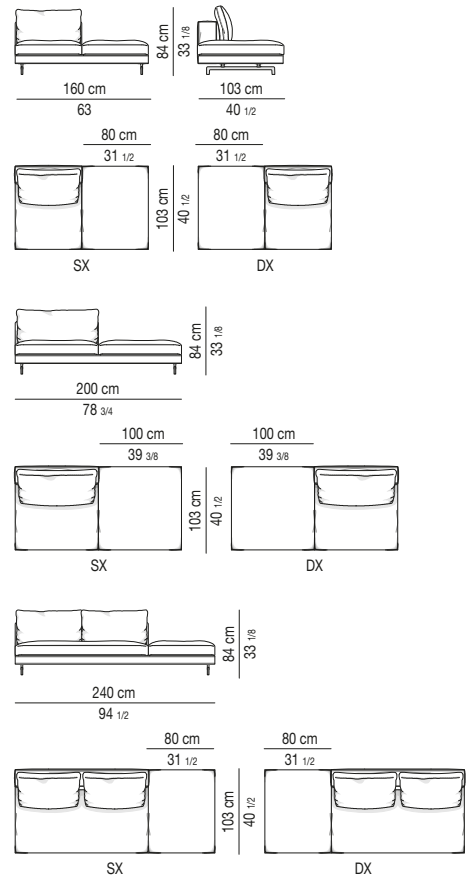

Minotti

COUCH

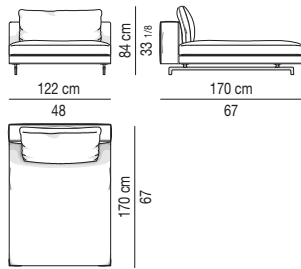
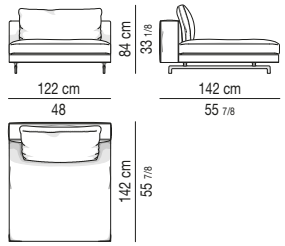
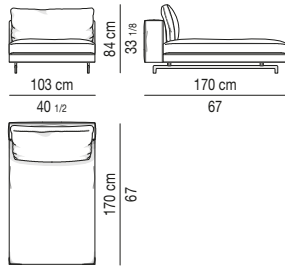

CHAISE LONGUE

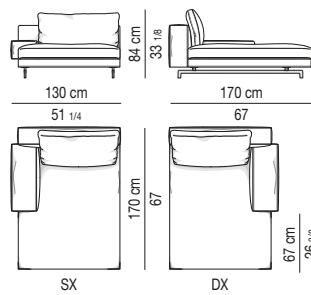
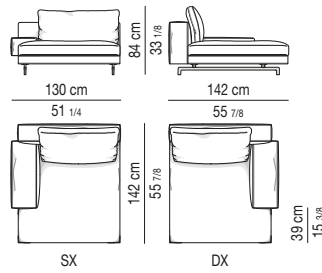
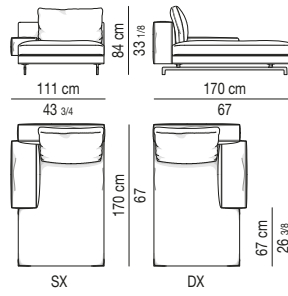

PANCA | BENCH

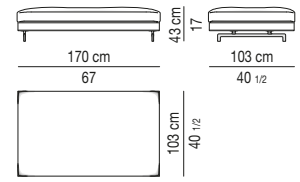

POUF | STOOL

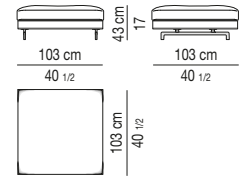

CUSCINO OPTIONAL | OPTIONAL CUSHION

