



Il sistema di sedute Williams colpisce con immediatezza e quindi è destinato a diventare un classico, questo racconta la tradizione Minotti. Grande personalità estetica, proporzioni eleganti, comfort. Comfort che nasce da una schiuma intelligente e termosensibile di nuova generazione: si automodella e permette di distribuire il peso nel modo più conveniente. Il sistema Williams è variamente declinabile - versione Williams, Williams "Square" e Williams "Mix" - e dà origine a combinazioni più o meno formali. Flessibile, interpreta le diverse esigenze contemporanee di convivialità e comfort. A un primo contatto con il design, si coglie il valore di linee semplici ma mai semplicistiche. La ricchezza è nell'estrema cura dei dettagli: elegante base modellata al laser e finitura in titanio-nickel capace di conferire un aspetto flottante di assoluto rigore estetico. Gli utilizzi e le performance del prodotto si moltiplicano con gli abbinamenti a sofisticate Williams "Console" dalle studiatissime dimensioni, a piani di vetro bronzato o speciali laccature antigraffio. Oltre ad un evidente senso pratico, queste console imprime all'area living un forte impulso estetico: decorano infatti il divano con dinamici giochi di forme. Infine Williams "Small", ultima interpretazione del progetto Williams per rispondere all'esigenza di sedute dalle dimensioni più contenute. Si adattano a spazi domestici ridotti o ambienti collettivi senza rinunciare però all'eleganza, alla cura del dettaglio, al carattere di stile e qualità Williams. Small size ma con un grande charme.

Struttura: in legno massello e multistrato.

Preparazione della struttura: poliuretano espanso a quote differenziate.

Cinghie: cinghie elastiche ad alta componente di caucciù e ad elasticità controllata.

Cuscinatura: imbottitura cuscino seduta in piuma d'oca canalizzata con inserto centrale in poliuretano espanso ad alta resilienza, rivestito ulteriormente, sotto e sopra, con materiale poliuretano "termosensibile". Cuscini schienale totalmente imbottiti in piuma d'oca canalizzata.

Base: in metallo a sezione rettangolare mm 60x10, con finitura black-nickel lucida. Appoggio a terra tramite scivolanti protettivi in nylon nero morbido.

Sfoderabilità: il rivestimento è completamente sfoderabile nella versione in tessuto allentando le viti poste sotto le staffe anteriori e posteriori, con apposita chiave in dotazione. Nella versione in pelle il rivestimento è fisso per la struttura, mentre è sfoderabile per i cuscini schienale e per i cuscini seduta.

The Williams seating system strikes you immediately; hence it is going to grow into a classic, in line with Minotti's tradition. A remarkable aesthetic character, elegant proportions, comfort. Comfort in particular results from a smart, thermosensitive new-generation foam: self-moulded, it allows weight to be properly distributed. The Williams system is available in several versions - Williams, Williams "Square" and Williams "Mix" -, making both formal and more informal combinations possible. Flexible, it caters to the contemporary need for convivial situations and comfort. When you come across the design, you become aware of simple - though not oversimplified - lines. Richness is provided by the extremely accurate details: a smart, laser-shaped, titanium nickel finished base translating into a floating appearance synonymous with unique aesthetic rigour. Uses and performances multiply as the product is matched with sophisticated Williams consoles, based on carefully studied dimensions, bronzed glass tops or special scratch-proof lacquer. As well as clearly standing out as practical, these consoles give the living area a major aesthetic boost: they decorate the sofa with dynamic shape effects. Finally, Williams "Small", the latest interpretation of the Williams project, answers the need for more compact seats. It fits both small home and public spaces, without giving up elegance, care for details, the Williams style and quality. Small sized, yet extremely charming.

Frame: in solid wood and multi-ply wood.

Frame preparation: polyurethane foam of various densities.

Straps: woven elastic straps with a high rubber content and controlled elasticity.

Cushions: seat cushion padded with goose down divided into sections; high resilience central polyurethane inset; further lined and covered with "thermosensitive" polyurethane material. Backrest cushions fully padded with goose down divided into sections.

Base: in metal with rectangular section mm 60x10; bright black-nickel finish, with soft black nylon glides.

Covers: fully removable in the fabric version by loosening the screws under the front and rear stirrups, using the spanner supplied with the sofa. Leather cover of the frame non-removable; removable backrest and seat cushion covers.

Das Sitzsystem Williams verzaubert auf den ersten Blick und ist somit ganz im Zuge der Tradition Minotti von vornherein zum Klassiker bestimmt. Große optische Persönlichkeit, elegante Proportionen und Komfort. Komfort, der auf einen intelligenten und wärmeempfindlichen Schaum der neuen Generation zurückgeht: Dieser ist selbstformend und ermöglicht eine bestmögliche Gewichtsverteilung. Das System Williams ist vielfach veränderbar - Version Williams, Williams "Square" und Williams "Mix" - und Ursprung mehr oder weniger formeller Kombinationen. Mit Flexibilität interpretiert es die unterschiedlichen Ansprüche heutiger Geselligkeits- und Komfortanforderungen. Beim ersten Zusammentreffen mit dem Design spürt man die Wertigkeit einfacher, aber keinesfalls banaler Linien. Reichhaltigkeit kommt dagegen in der extremen Detailliebe zum Ausdruck: Eine elegante, lasergeformte Basis und Nickel-Titan-Finishs, die eine flottierende Optik von hohem rigorosen Anspruch vermittelt. Die Produktleistungen und -anwendungsmöglichkeiten vervielfachen sich durch mögliche Kombinationen mit auserlesenen und bezüglich der Abmessungen gezielt entwickelten Williams "Konsolen" mit Platten aus Bronzeglas oder mit einer speziellen kratzfesten Lackierung. Diese Konsolen sind nicht nur offensichtlich praktisch, sondern verleihen dem Wohnbereich auch eine prägnante optische Ausstrahlung: Tatsächlich werden sie sich mit ihren dynamischen Formspielen zu einer Art Dekor des Sofas. Williams "Small", die letzte Interpretation des Projekts Williams, kommt schließlich der Anforderung nach kleiner dimensionierten Sitzflächen nach. "Small" eignet sich für kleinere Wohn- oder Gemeinschaftsräume ohne deshalb Abstriche bezüglich Eleganz, Detailliebe, stilistischem Charakter und der Qualität Williams zu machen. Small Size und viel Charme.

Rahmen: aus Massivholz und aus Mehrschichtplatten.

Herstellung des Rahmens: aus Polyurethanschaum in unterschiedlicher Dichte.

Riemen: elastische Riemen mit hohem Kautschukanteil und kontrollierter Elastizität.

Kissen: Sitzkissenfüllung aus kanalisierten Gänsedaunen mit einem mittigen, hoch kerzbähen PU-Schaum-Einsatz. Unten und oben zusätzlicher Bezug durch "wärmesensibles" Polyurethan-Material (siehe seitliche Anmerkung). Komplett mit kanalisierten Gänsedaunen gefüllte Rückenlehnenkissen.

Gestell: Grundgestell aus Metall mit rechteckigem Schnitt mm 60x10 im Black-Nickel-Glanzfinish. Bodenaufgabe durch weichen, schwarzen Nylonrutschschutz zur Vermeidung.

Abnehmbare Bezüge: nur der Stoffbezug ist abziehbar. Hierzu die unter den vorderen und hinteren Bügeln positionierten Schrauben mit dem im Lieferumfang enthaltenen Schlüssel lösen. Fester Lederbezug nur für das Gestell. Rückenlehnen- und Sitzkissen sind abziehbar.

Étonnant dans sa spontanéité, le système d'assises Williams est fait pour devenir un vrai classique du genre, dans la plus pure tradition Minotti. Une grande personnalité esthétique, des proportions élégantes et un confort sans égal. Un confort procuré par une mousse intelligente et termosensible de nouvelle génération à mémoire de forme, qui permet de distribuer au mieux le poids. Le système Williams se décline de plusieurs façons - version Williams, Williams "Square" et Williams "Mix" - afin de créer des combinaisons plus ou moins formelles. Polyvalent, il sait parfaitement interpréter les diverses exigences contemporaines de la convivialité et du confort. La première approche du design laisse transparaître la valeur de lignes simples, mais jamais simplistes. Sa richesse réside dans le soin extrême accordé aux détails : sa base élégante et modelée au laser avec finition en titane-nickel procure un sens de légèreté d'une rigueur esthétique absolue. Les utilisations et les performances du produit se multiplient en procédant à des associations sophistiquées avec des Williams "Console" aux dimensions spécialement étudiées, avec des plateaux en verre bronzé ou des laquages spéciaux anti-graflure. Outre leur praticité évidente, ces consoles apportent au living une forte valeur esthétique : elles décorent en effet le divan avec des jeux de formes dynamiques. Williams "Small" est la toute dernière réalisation du projet Williams, conçue pour répondre aux besoins d'assises de dimensions plus réduites. Elle s'adapte aux espaces domestiques plus petits ou aux espaces collectifs sans jamais renoncer cependant à l'élégance, au soin des détails, au style et à la qualité Williams. Petite de taille mais grande de charme.

Structure: en bois massif et multicouche.

Préparation de la structure: polyuréthane expansé à hauteurs différenciées.

Sangles: sangles élastiques tressées à haute teneur en caoutchouc et à élasticité contrôlée.

Coussins: rembourrage du coussin de l'assise en plume d'oie à secteurs avec élément central en polyuréthane expansé haute résilience, avec revêtement additionnel, dessous et dessus, en polyuréthane "thermosensible". Coussins du dossier entièrement rembourrés avec de la plume d'oie à secteurs.

Base: en métal de section rectangulaire mm 60x10, avec finition black-nickel polie. Piètement avec patins en nylon noir souple.

Possibilité d'enlever la housse: revêtement en tissu déhoussable en desserrant les vis placées sous les brides avant et arrière à l'aide de la clé ad hoc fournie. Revêtement en cuir fixe uniquement pour la structure, coussins, dossier et assise déhoussables.

Minotti

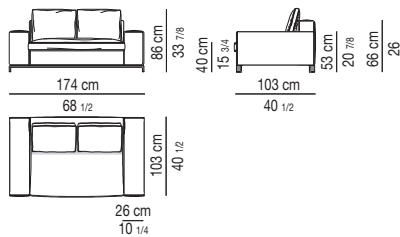

WILLIAMS "SQUARE"

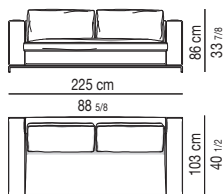

OPZIONE | OPTION "SINGLE-SEATS"

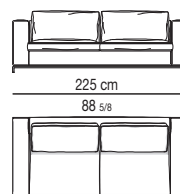

WILLIAMS "SQUARE"

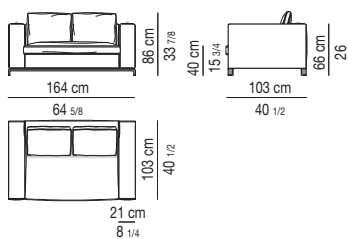

WILLIAMS "MIX"

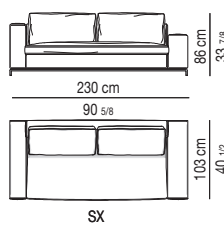

OPZIONE | OPTION "SINGLE-SEATS"

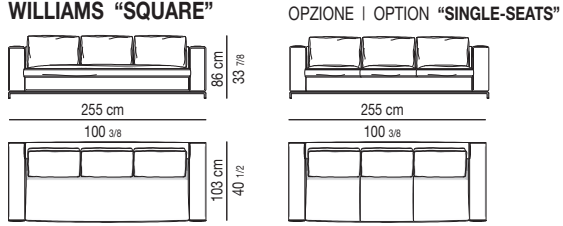
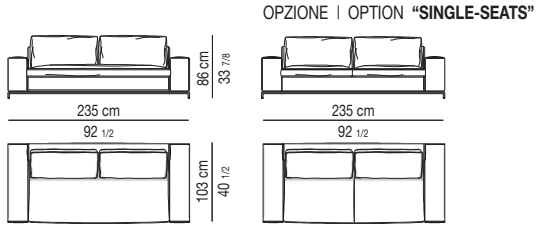
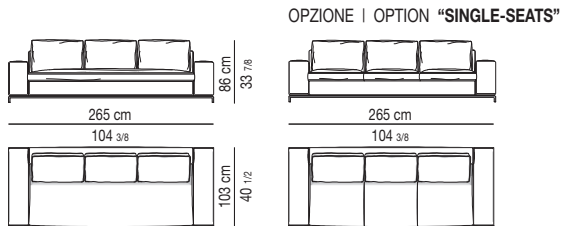
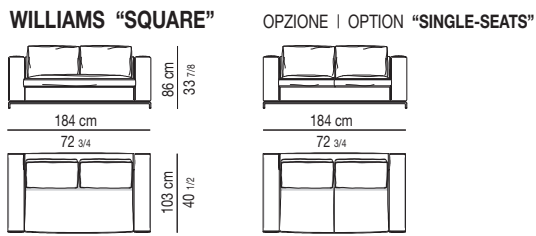
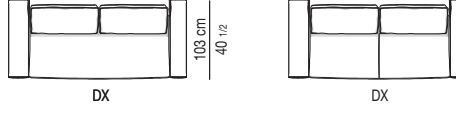
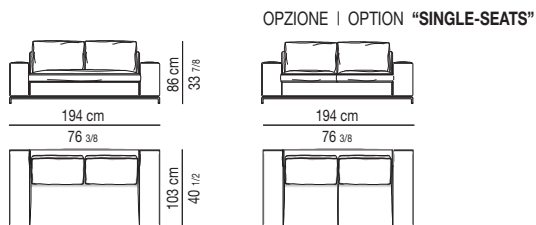
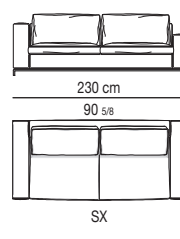

Minotti

WILLIAMS "MIX"

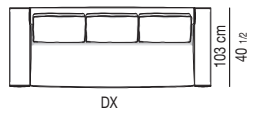
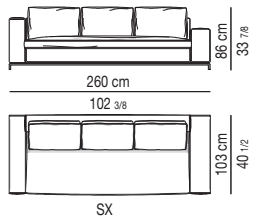

OPZIONE | OPTION "SINGLE-SEATS"

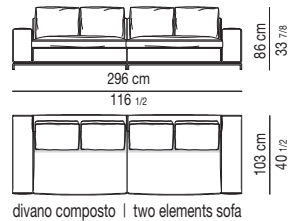
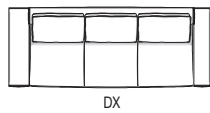
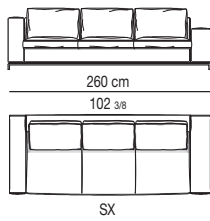

OPZIONE | OPTION "SINGLE-SEATS"

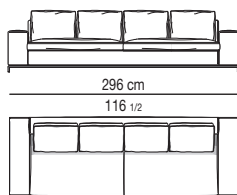
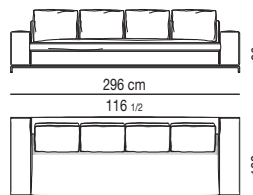

WILLIAMS "SQUARE"

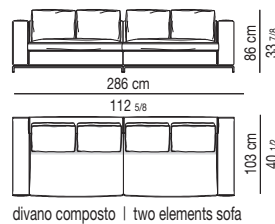

WILLIAMS "SQUARE"

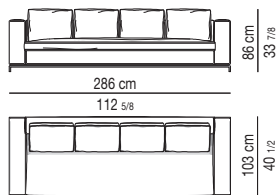

OPZIONE | OPTION "SINGLE-SEATS"

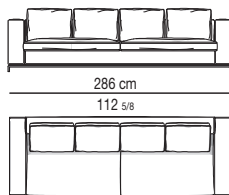

WILLIAMS "MIX"

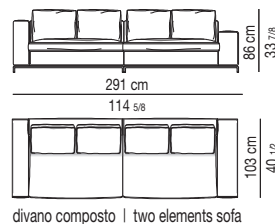

WILLIAMS "MIX"

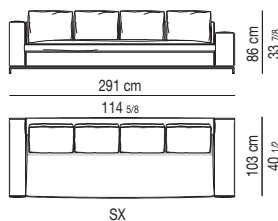

OPZIONE | OPTION "SINGLE-SEATS"

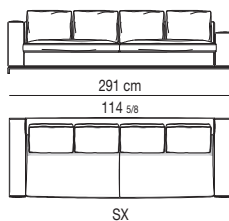

OPZIONE | OPTION "SINGLE-SEATS"

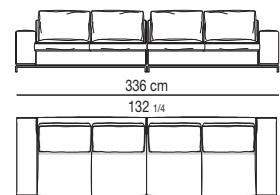
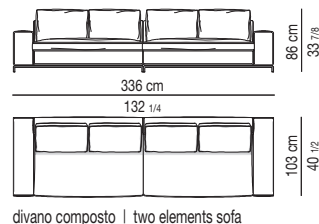

Minotti

WILLIAMS "SQUARE"

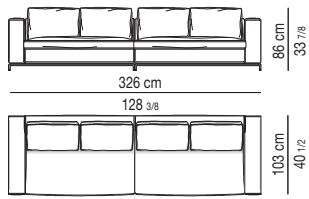

divano composto | two elements sofa

OPZIONE | OPTION "SINGLE-SEATS"

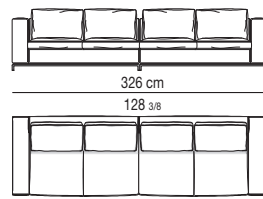

WILLIAMS "MIX"

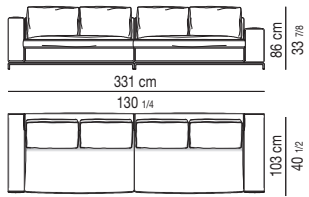

divano composto | two elements sofa

OPZIONE | OPTION "SINGLE-SEATS"

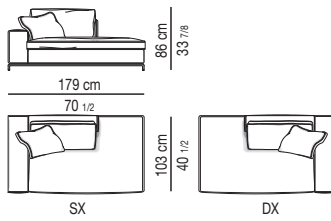
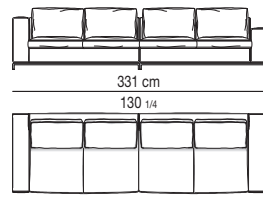

SX

DX

WILLIAMS "SQUARE"

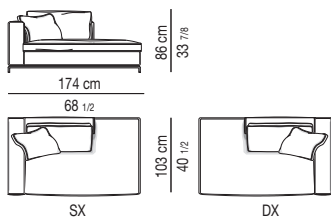

SX

DX

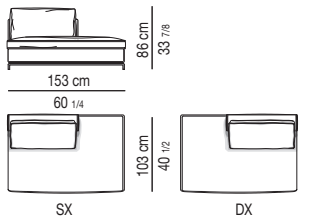

SX

DX

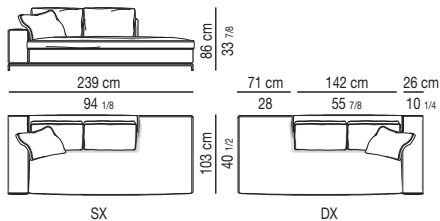

SX

DX

WILLIAMS "SQUARE"

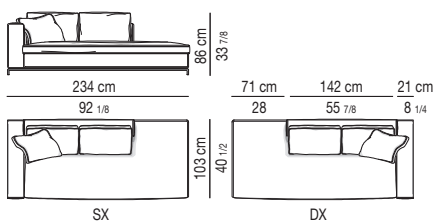

SX

DX

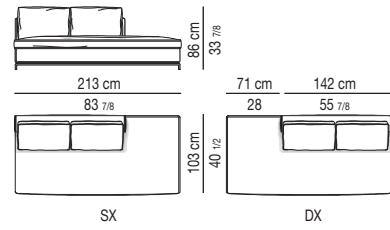

SX

DX

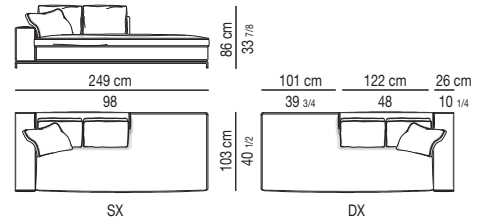

SX

DX

WILLIAMS "SQUARE"

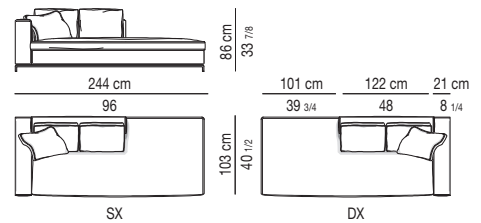

SX

DX

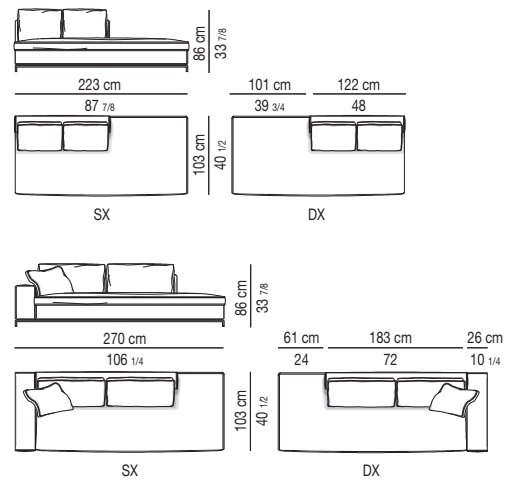

SX

DX

WILLIAMS "SQUARE"

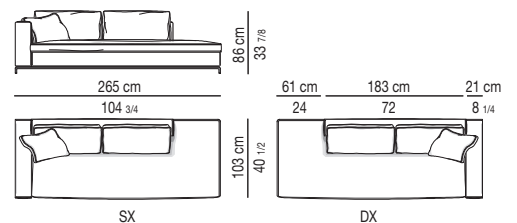

SX

DX

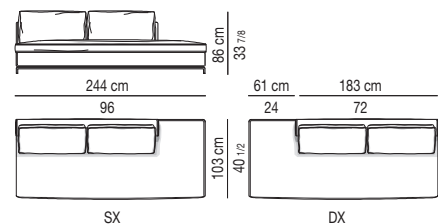

SX

DX

Minotti

WILLIAMS "SQUARE"

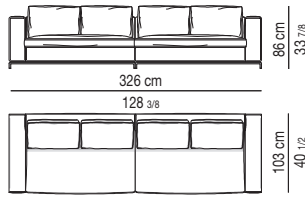

divano composto | two elements sofa

OPZIONE | OPTION "SINGLE-SEATS"

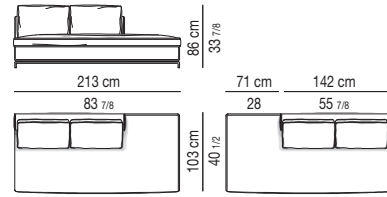
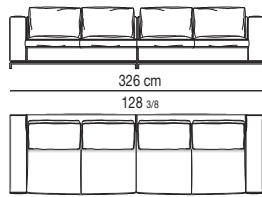

SX

DX

WILLIAMS "MIX"

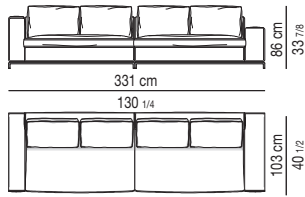

divano composto | two elements sofa

OPZIONE | OPTION "SINGLE-SEATS"

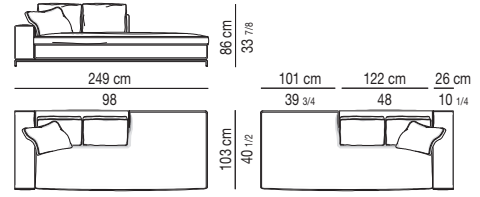
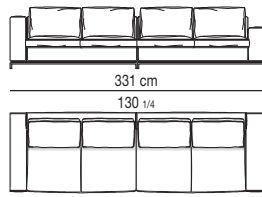

SX

DX

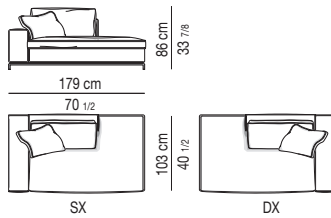

SX

DX

WILLIAMS "SQUARE"

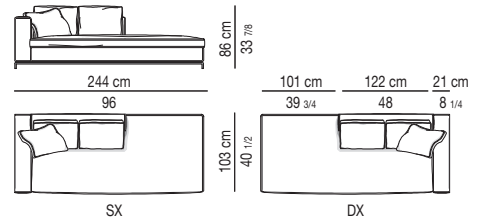

SX

DX

WILLIAMS "SQUARE"

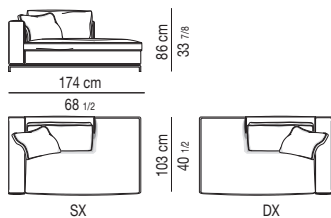

SX

DX

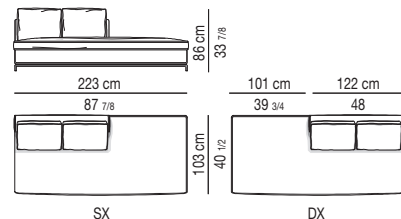

SX

DX

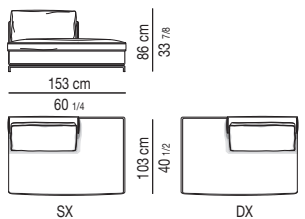

SX

DX

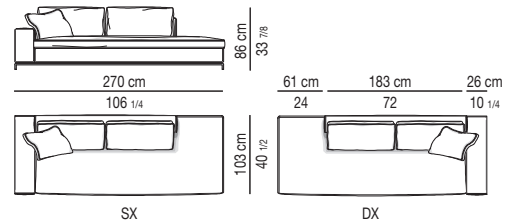

SX

DX

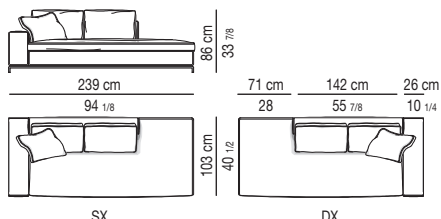

SX

DX

WILLIAMS "SQUARE"

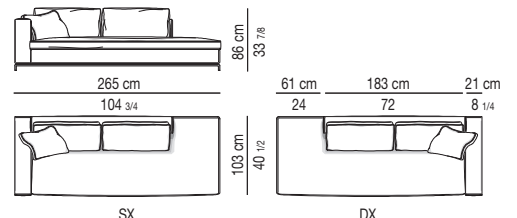

SX

DX

WILLIAMS "SQUARE"

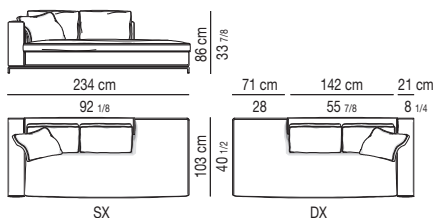

SX

DX

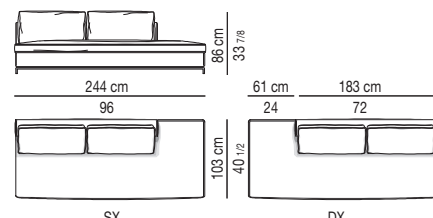

SX

DX

Minotti

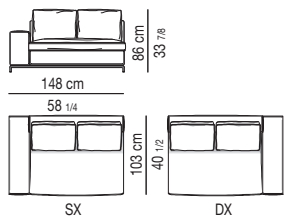

WILLIAMS "SQUARE"

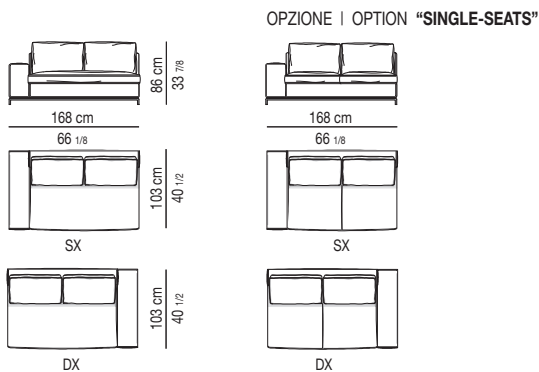
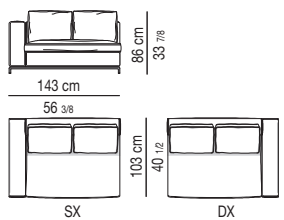

WILLIAMS "SQUARE"

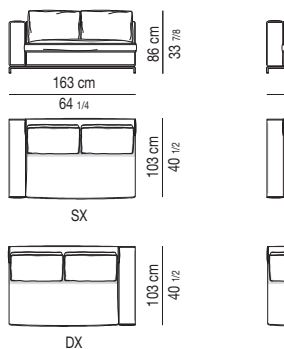

OPZIONE | OPTION "SINGLE-SEATS"

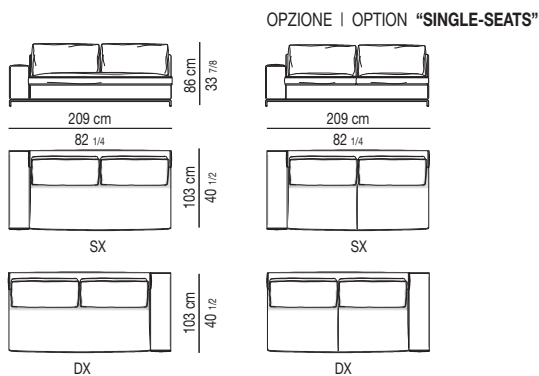
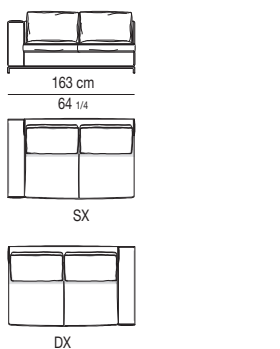

WILLIAMS "SQUARE"

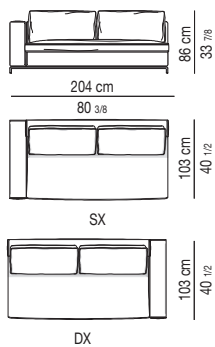

OPZIONE | OPTION "SINGLE-SEATS"

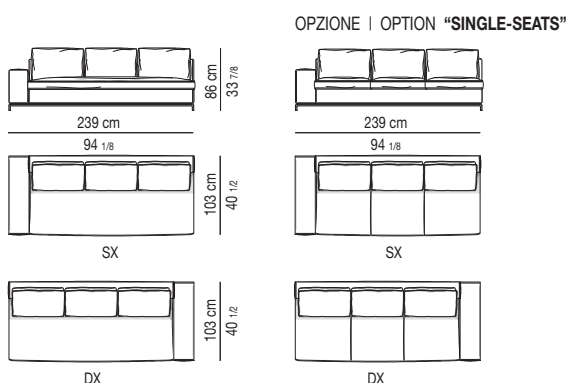
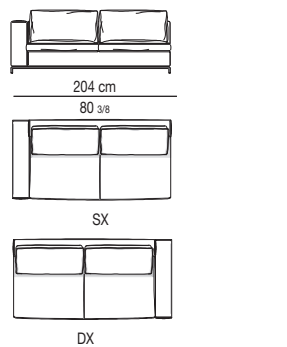

WILLIAMS "SQUARE"

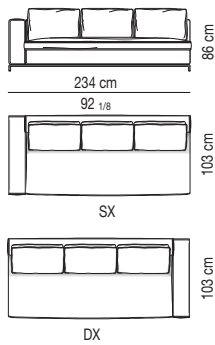

OPZIONE | OPTION "SINGLE-SEATS"

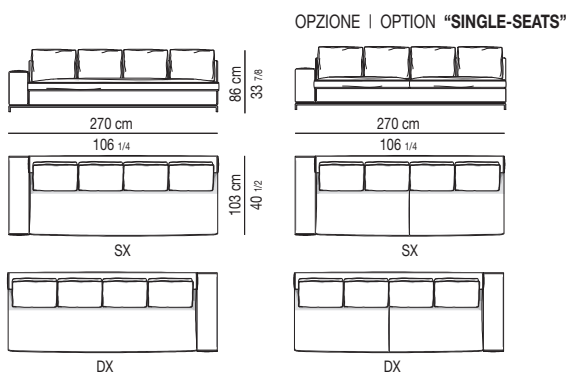

Minotti

WILLIAMS "SQUARE"

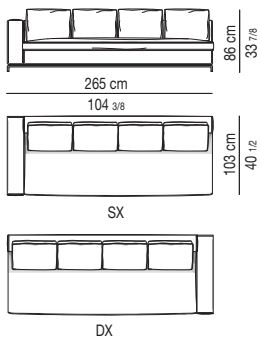

OPZIONE | OPTION "SINGLE-SEA"

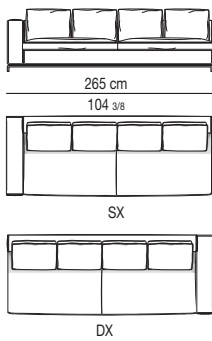

OPZIONE | OPTION "SINGLE-SEATS"

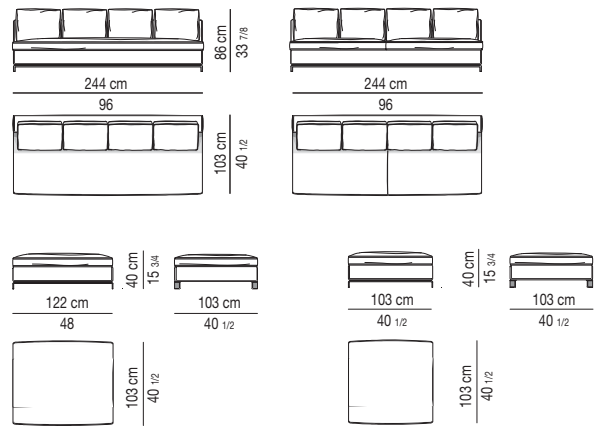

NEW

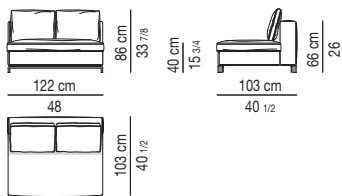
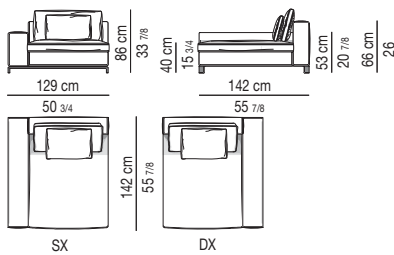
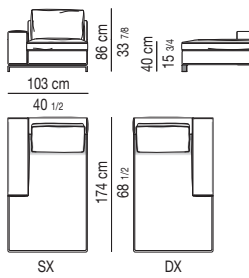

OPZIONE | OPTION "SINGLE-SEAT"

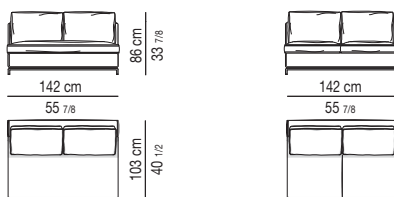

OPZIONE | OPTION "SINGLE-SEAT"

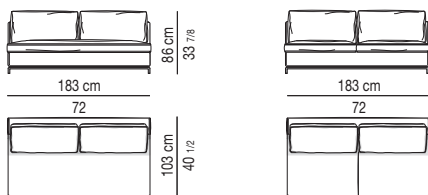

OPZIONE | OPTION "SINGLE-SEAT"

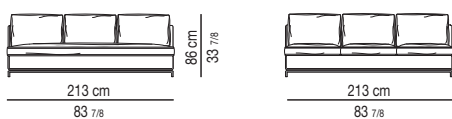

CUSCINI OPTIONAL | OPTIONAL CUSHIONS

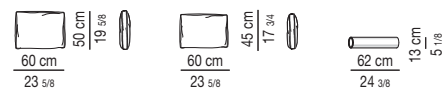

WILLIAMS SMALL DESIGN RODOLFO DORDONI

