

TECHNISCHE GEGEVENS

# ROLF BENZ 310

---



**ROLF  
BENZ**

- Houten binnenromp
- Nosag veren
- Rug van polyurethaanschuim
- Zitting van polyurethaanschuim, gelaagde opbouw, met verschillende hoogtes en uitvoeringen op elkaar afgestemd
- Bekleding onderzijde, met polyestervlies
- Stalen spang naar keuze:
  - roestvrij staal
  - gelakt in RAL 9017 Verkeerszwart

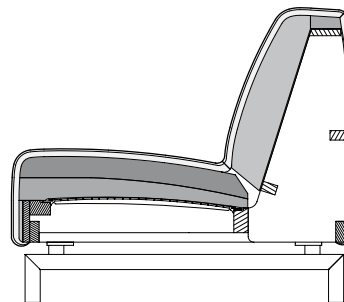

! Ploovorming en zitspiegel zijn vanwege comfort- en designredenen ook bij hoogwaardige, gestoffeerde Rolf Benz-meubels niet te vermijden. Alle maten zijn circa-maten.

Fauteuil

Bank

Zithoogtes leverbaar

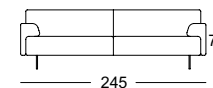
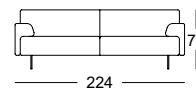
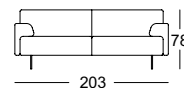
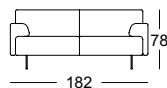
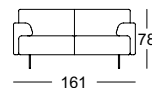
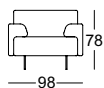
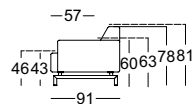
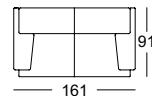
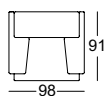
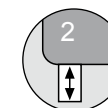

**ROLF  
BENZ**

Aanbouwbank\*

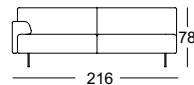
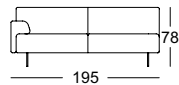
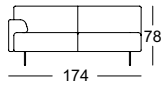
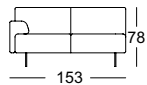
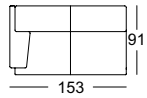

Hoek-aanbouwbank\*

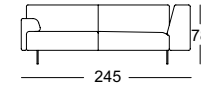
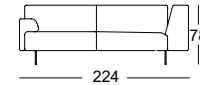
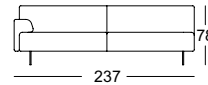
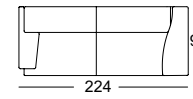

Aanbouwbank

Hoek-aanbouwbank\*

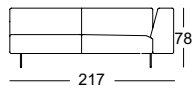
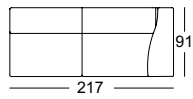

Aanbouwbank met zitting\*

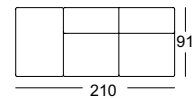

Hoek-aanbouwbank met zitting\*

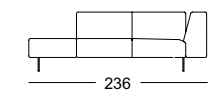
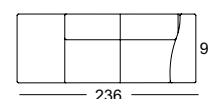

Voetenbank groot

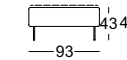
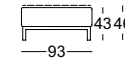
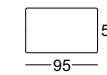

Voetenbankje

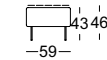
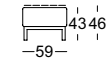

Combinatie voorbeelden:

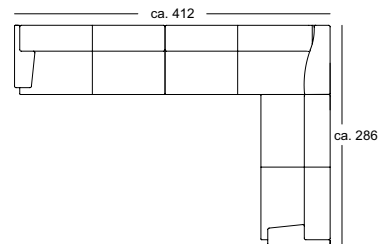

ASO 310/195 li.  
E-ARB 310/217 li.  
ASO 310/195 re.

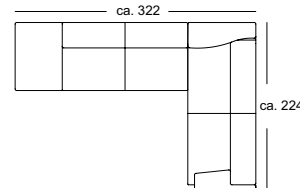

ARB-PSZ 310/231 li.  
E-ASO 310/224 re.

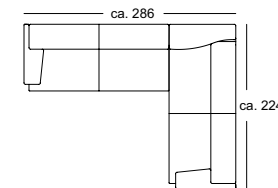

ASO 310/195 re.  
E-ASO 310/224 li.

\*Deze elementen zijn als linker uitvoering afgebeeld, ze zijn echter ook in spiegelbeeld, in de rechter uitvoering leverbaar.